

EURO-DESIGN 86 PLUS
TECHNISCHE INFORMATION
PROFILDRUCK

EURO-DESIGN 86 PLUS

PROFILDRUCK

Blendrahmen

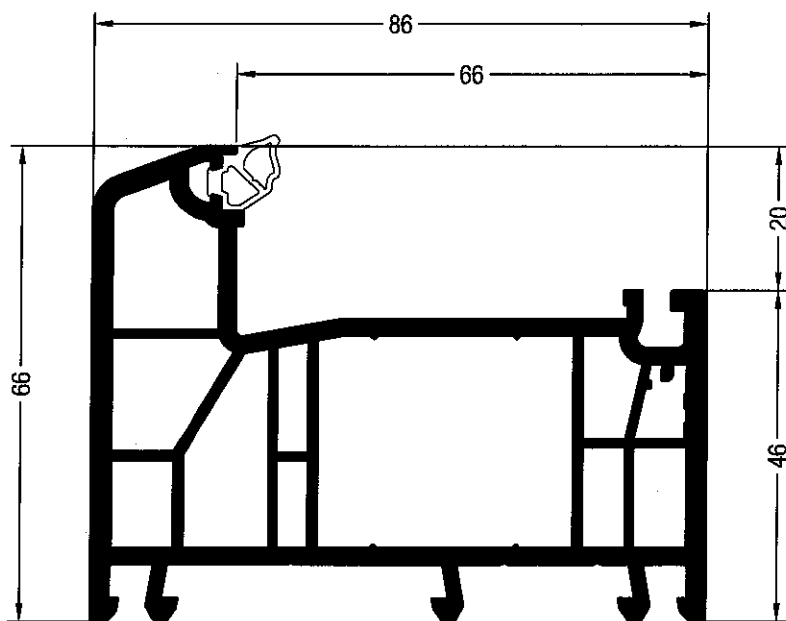

Blendrahmen 66 ED86 plus

- 1532505
- 1562505
- 24

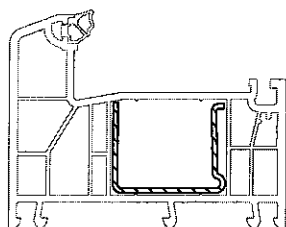

35 x 28

	1244506
	1,5
lx	2,5
ly	1,1
	6

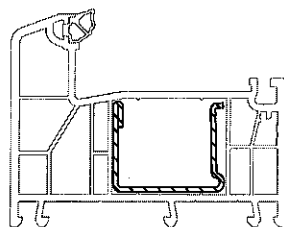

35 x 28

	1244516	1244526
	1,5	2
lx	2,7	3,5
ly	1,3	1,7
	6	6

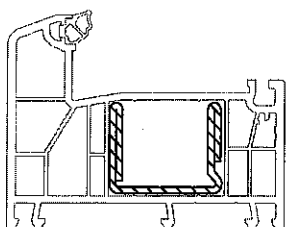

35 x 28

	1244536
	2
lx	5
ly	2
	6

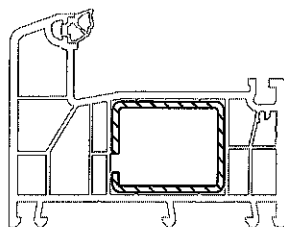

35 x 28

	1237091	1249934
	1,5	2
lx	2,8	3,4
ly	2,1	2,6
	6	6

EURO-DESIGN 86 PLUS

PROFILDRUCK

Blendrahmen

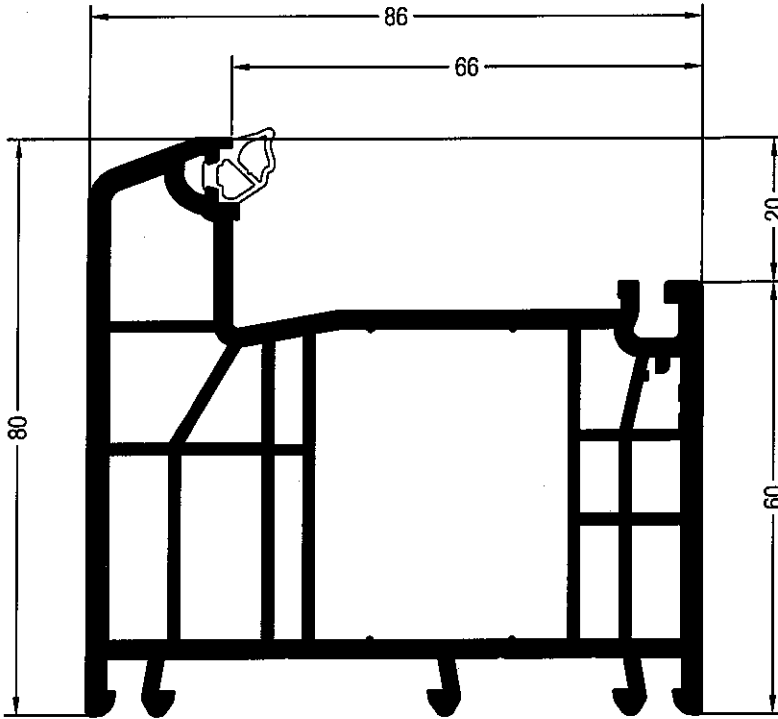

Blendrahmen 80 ED86 plus



1532515 

1562515 

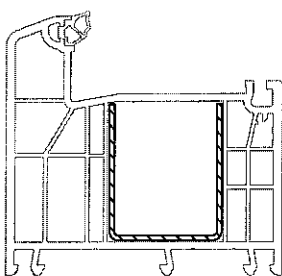
 24



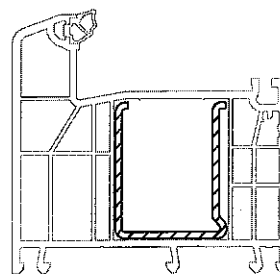

35 x 42

	1353061
	1,5
lx	3,9
ly	3,2
	6



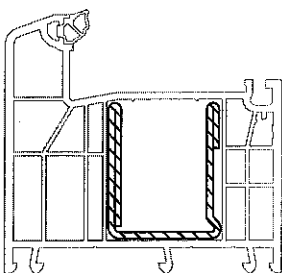

35 x 42

	1350193
	2
lx	4,6
ly	4,5
	6



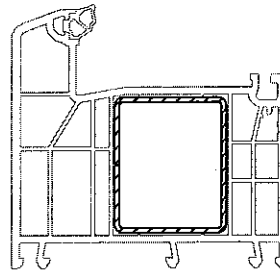

35 x 42

	1238570
	2
lx	6,5
ly	6,1
	6



35 x 42

	1353066
	1,5
lx	4,2
ly	5,6
	6

EURO-DESIGN 86 PLUS

PROFILDRUCK

Pfosten-Kämpfer

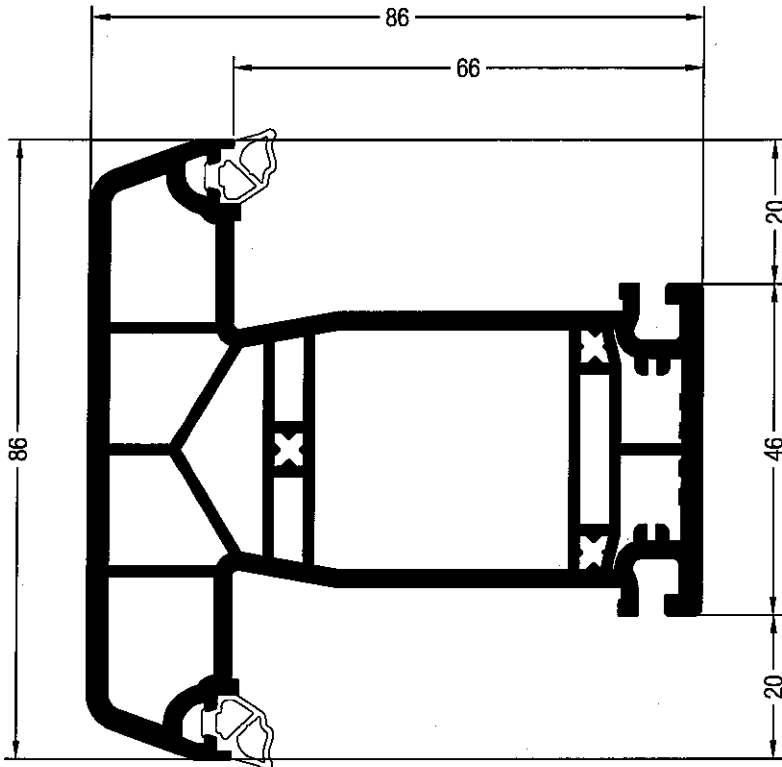

Pfosten 86 ED86 plus



1532575  

1562575  

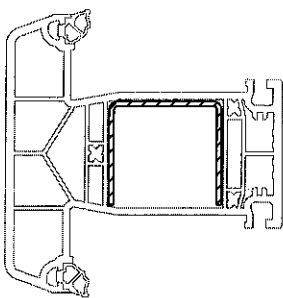
 24



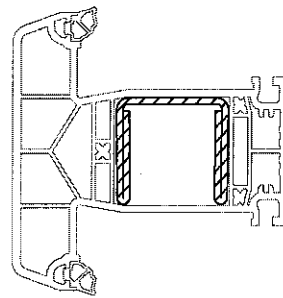

35 x 32

	1352519
	1,5
lx	3
ly	1,5
	6



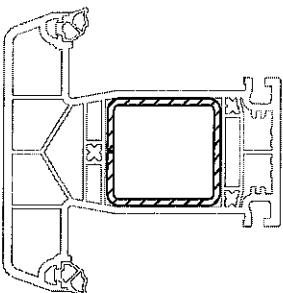

35 x 33

	1352521
	2
lx	6,2
ly	3,1
	6



35 x 33

	1352522
	2
lx	4,3
ly	3,9
	6



EURO-DESIGN 86 PLUS

PROFILDRUCK

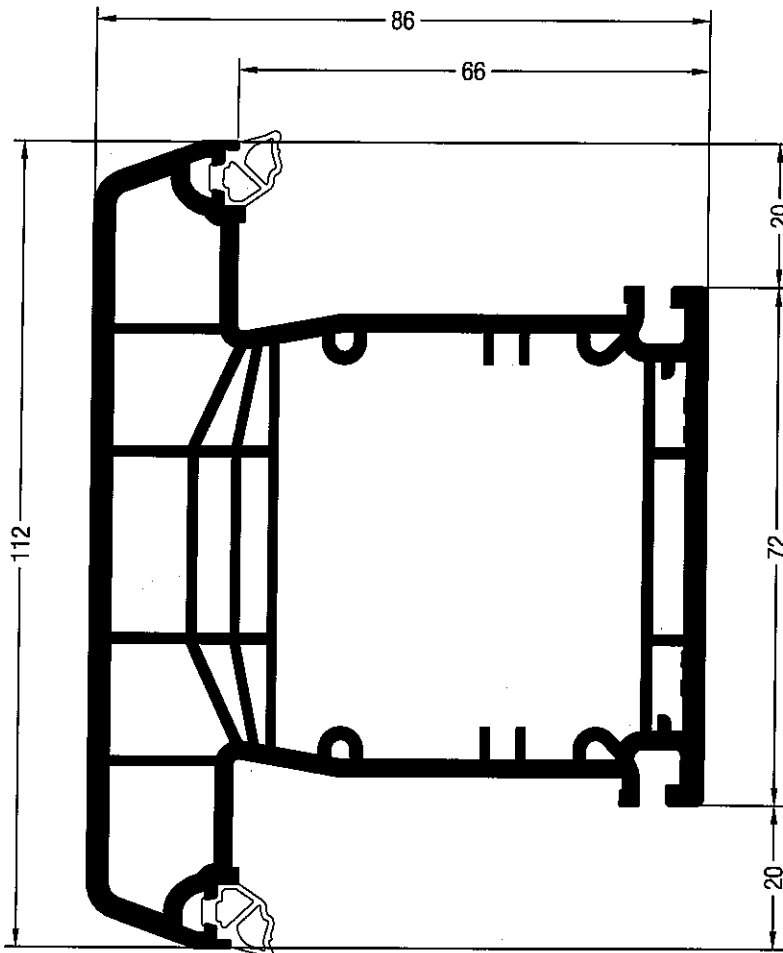
Pfosten-Kämpfer



Pfosten 112 ED86 plus

1532605  



1562605  

 12

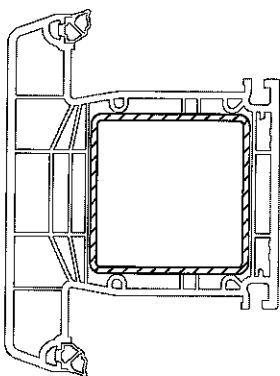
Lieferbar ab September 2011



50 x 50

	1253864
	2
lx	14,2
ly	14,2
	6

EURO-DESIGN 86 PLUS

PROFILDRUCK

Flügel

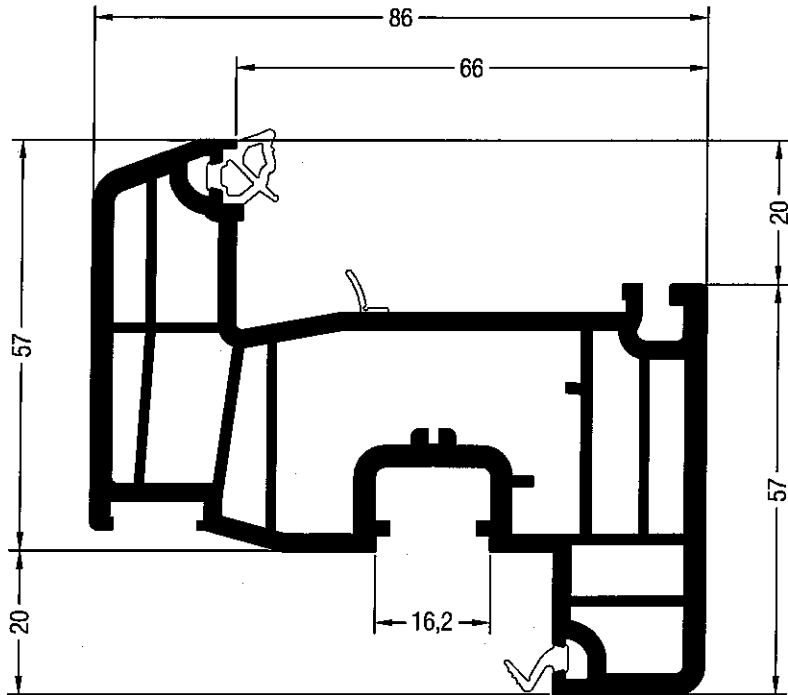

Flügel Z 57 ED86 plus



1532526 

1562526 

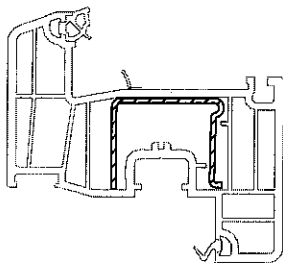
 24



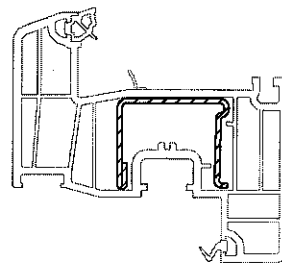

35 x 28

	1244506
	1,5
lx	2,5
ly	1,1
	6



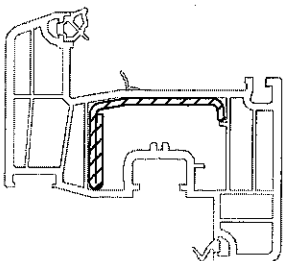

35 x 28

	1244516	1244526
	1,5	2
lx	2,7	3,5
ly	1,3	1,7
	6	6



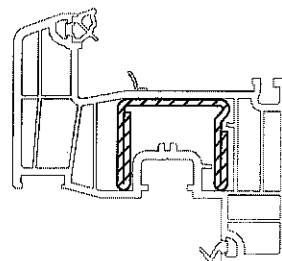

41,8 x 28

	1352515
	2
lx	3,3
ly	1,4
	6



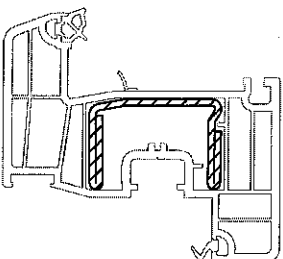

35 x 28

	1244536
	2
lx	5
ly	2
	6



41 x 28

	1352512
	2
lx	7,1
ly	2,1
	6

EURO-DESIGN 86 PLUS

PROFILDRUCK

Flügel

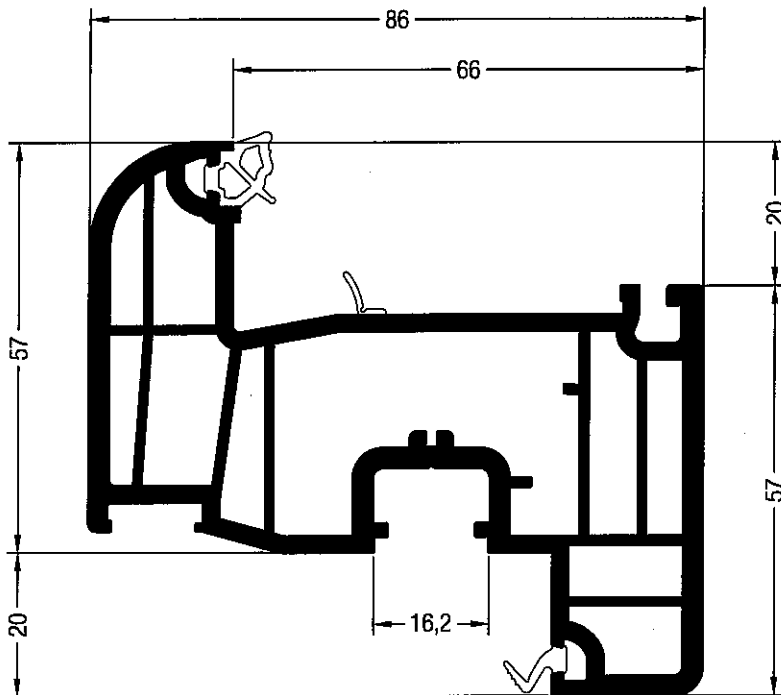

Flügel 57 rund ED86 plus

1532536 



1562536 

 24

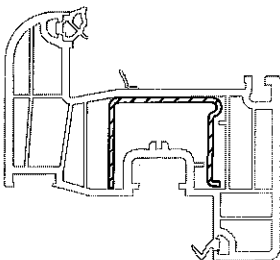
 Flügel 57 rund ist nicht in Verbindung mit glasteilenden Sprossen einsetzbar!



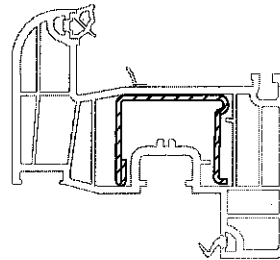

35 x 28

	1244506
	1,5
lx	2,5
ly	1,1
	6



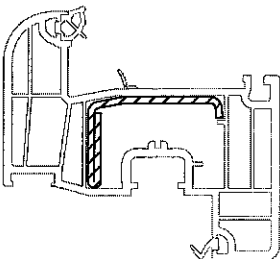

35 x 28

	1244516	1244526
	1,5	2
lx	2,7	3,5
ly	1,3	1,7
	6	6



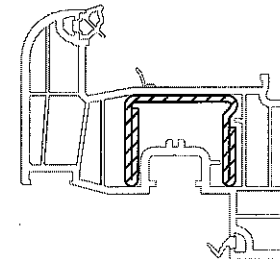

41,8 x 28

	1352515
	2
lx	3,3
ly	1,4
	6



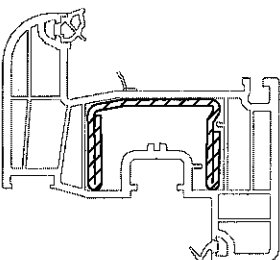

35 x 28

	1244536
	2
lx	5
ly	2
	6



41 x 28

	1352512
	2
lx	7,1
ly	2,1
	6

EURO-DESIGN 86 PLUS

PROFILDRUCK

Flügel

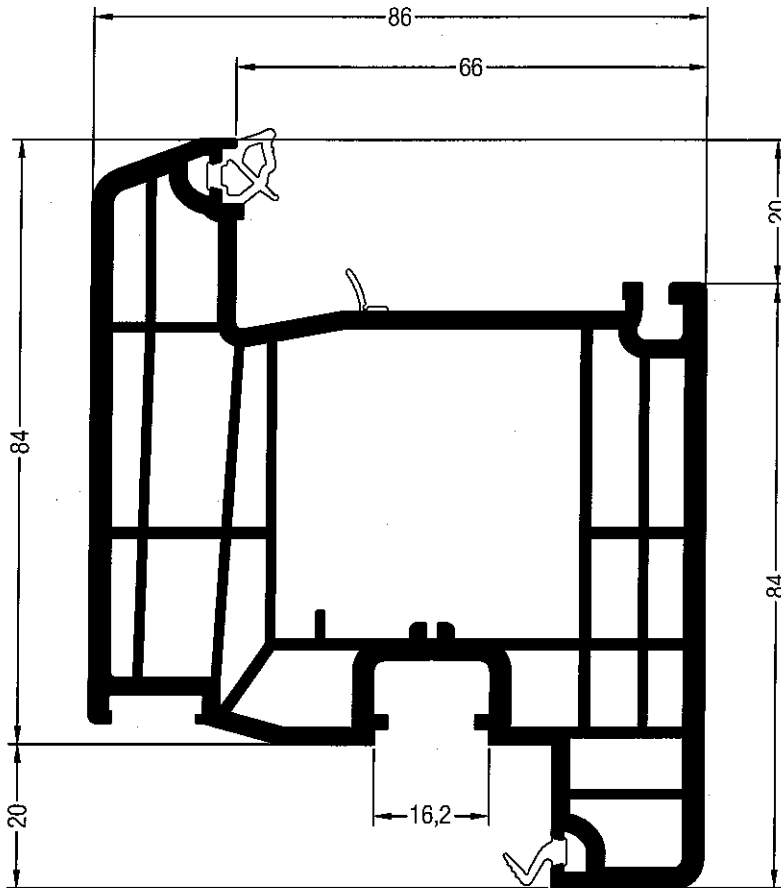

Flügel Z 84 ED86 plus



1532546 

1562546 

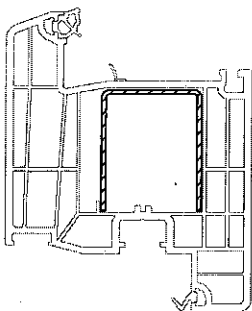
 24



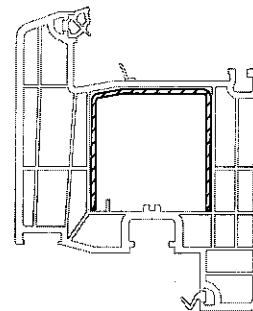

35 x 42

	1353061
	1,5
lx	3,9
ly	3,2
	6



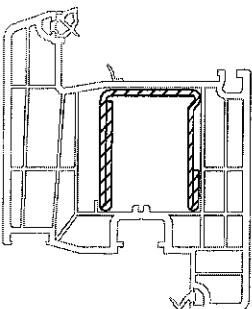

42 x 42

	1353065
	1,5
lx	5,7
ly	3,4
	6



35 x 42

	1238570
	2
lx	6,5
ly	6,1
	6

EURO-DESIGN 86 PLUS

PROFILDRUCK

Flügel

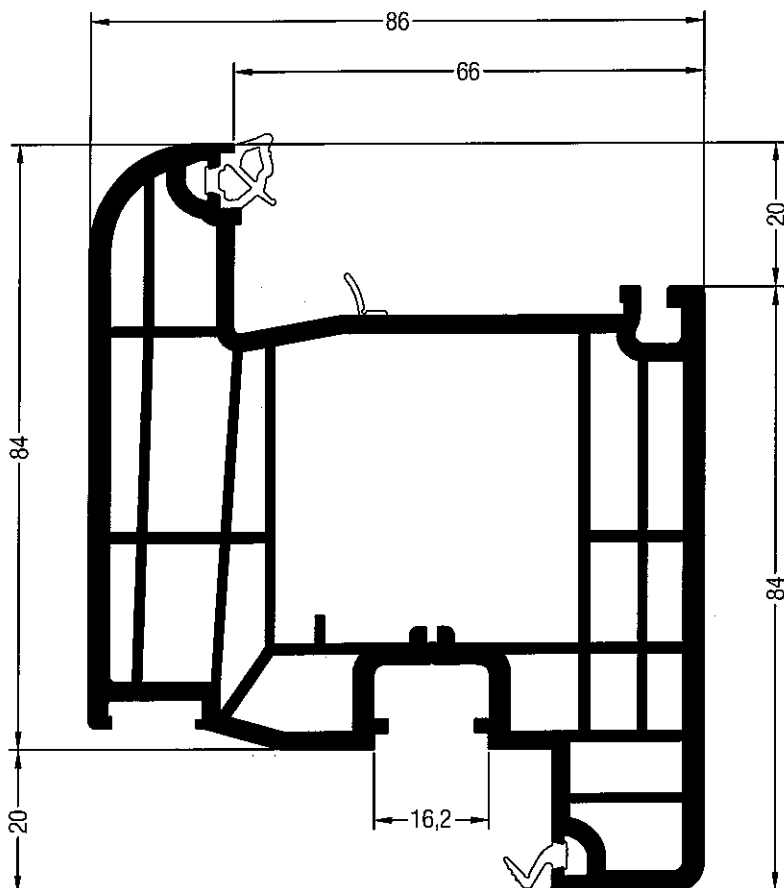

Flügel 84 rund ED86 plus

1532556

1562556

24

Flügel 84 rund ist nicht in Verbindung mit glasteilenden Sprossen einsetzbar!

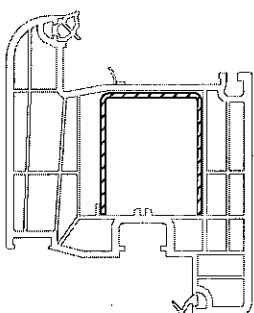

35 x 42

	1353061
	1,5
lx	3,9
ly	3,2
	6

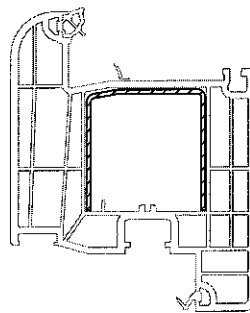

42 x 42

	1353065
	1,5
lx	5,7
ly	3,4
	6

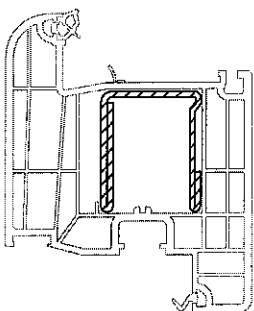

35 x 42

	1238570
	2
lx	6,5
ly	6,1
	6

EURO-DESIGN 86 PLUS

PROFILDRUCK

Flügel

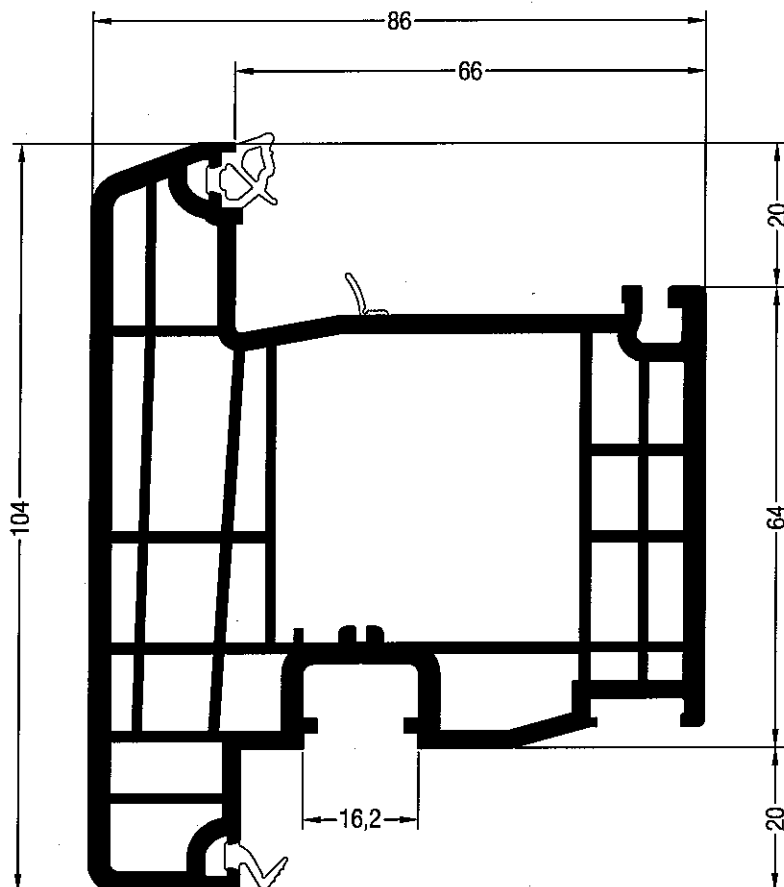

Flügel T 104 ED86 plus



1532566 

1562566 

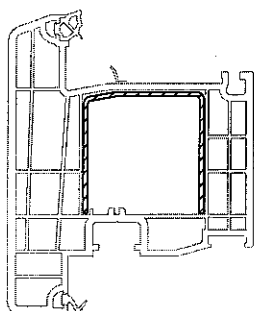
 12



42 x 42

	1353065	1355404
	1,5	2
ix	5,7	7,4
ly	3,4	4,4
	6	6

EURO-DESIGN 86 PLUS

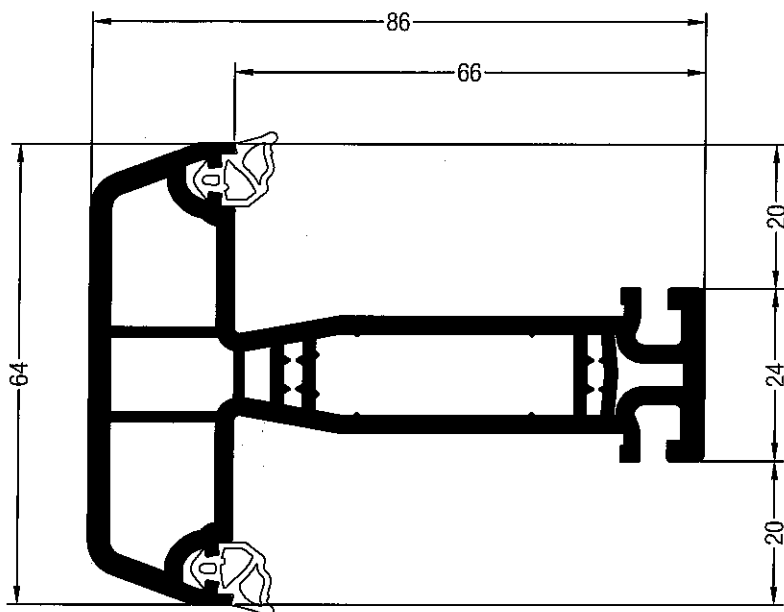

PROFILDRUCK

Flügelprossen



Sprosse 64/86



1532295  

1562295  

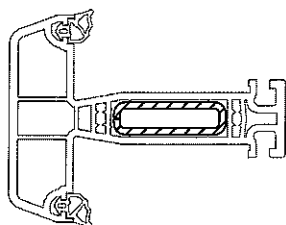
 36



35 x 10

	1261801
	2
lx	1,8
ly	0,22
	6

EURO-DESIGN 86 PLUS

PROFILDRUCK

Profile für mehrflügelige Fenster ohne festen Pfosten

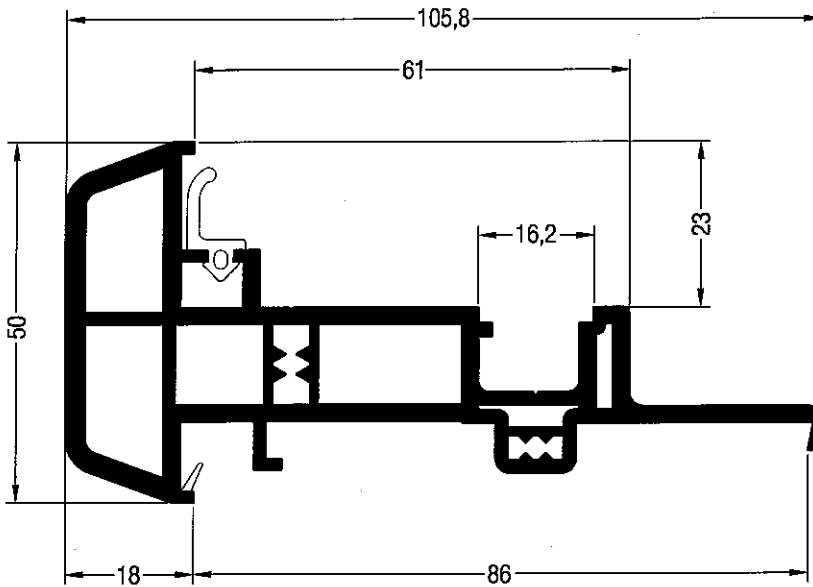

Stulpprofil ED86 plus

1532595

1562595

24

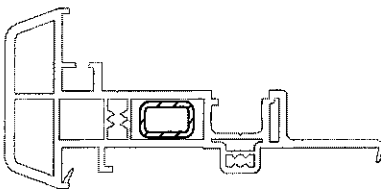

15 x 10

	1353173@
	1,5
lx	0,16
ly	0,08
	6

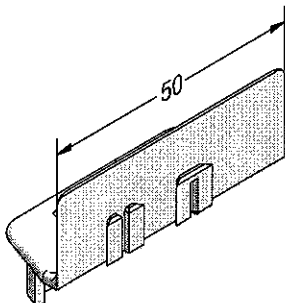

Endkappe Stulpprofil außen ED86 plus

ASA

1353000

1353001

50

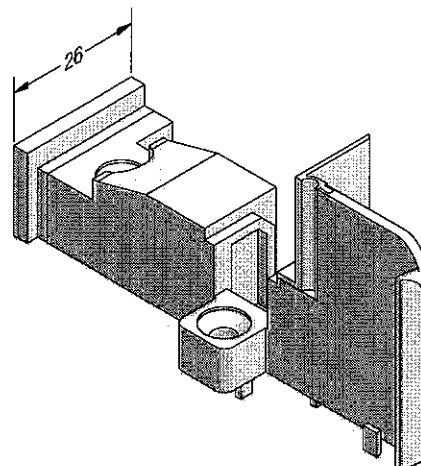

Endkappe Stulpprofil innen ED86 plus

ASA

1353002

1353003

50

EURO-DESIGN 86 PLUS

PROFILDRUCK

Bodenschwelle und Zubehör

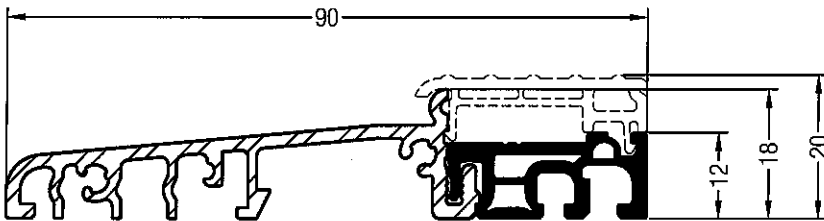
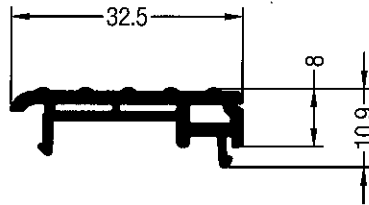

Set Bodenschwelle Bautiefe 86

1350308

6

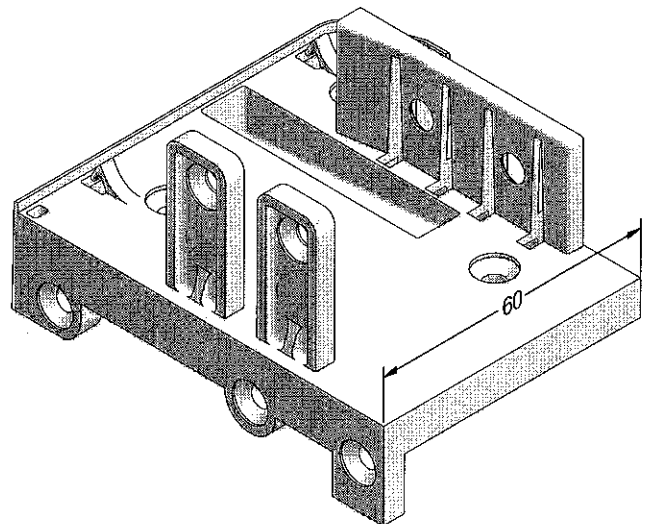
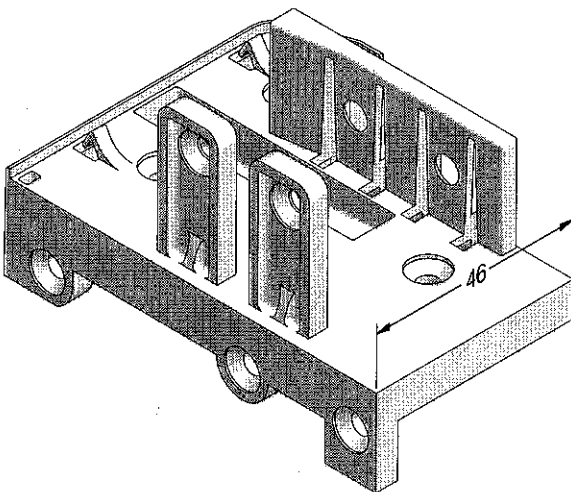

Schwellenhalter Blendrahmen 66 ED86 plus

ASA

1353006

1353007

50

Schwellenhalter Blendrahmen 80 ED86 plus

ASA

1353008

1353009

50

EURO-DESIGN 86 PLUS

PROFILDRUCK

Bodenschwelle und Zubehör

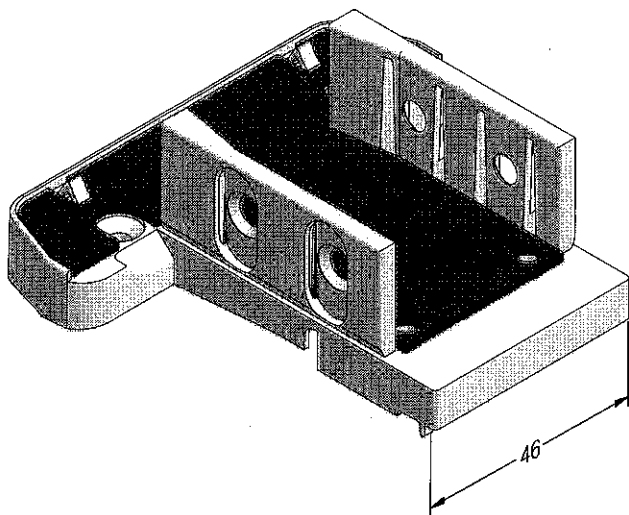

Schwellenhalter Pfosten 86 ED86 plus

ASA

1354006

 50

Lieferbar ab September 2011

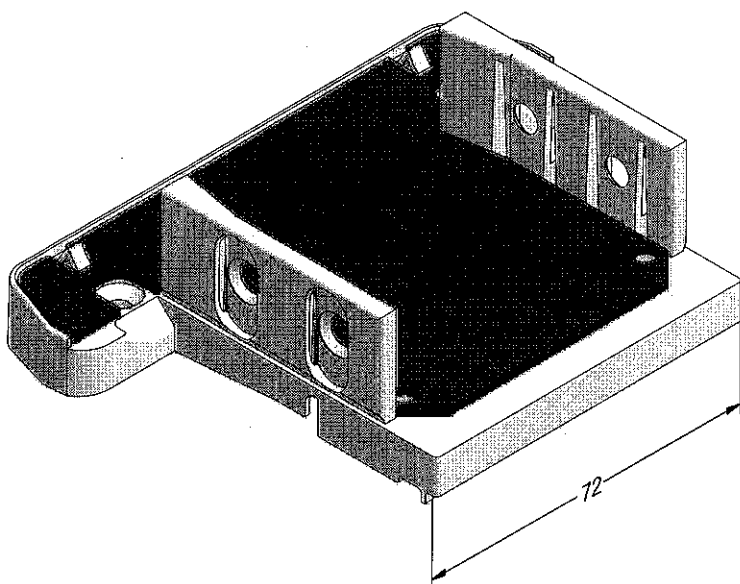

Schwellenhalter Statikpfosten 112 ED86 plus

ASA

1354012

 50

Lieferbar ab September 2011

EURO-DESIGN 86 PLUS

PROFILDRUCK

Bodenschwelle und Zubehör

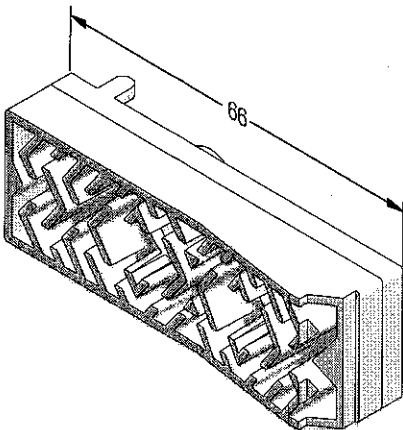

Windstopp ED86 plus
ASA/TPE

1353013

100

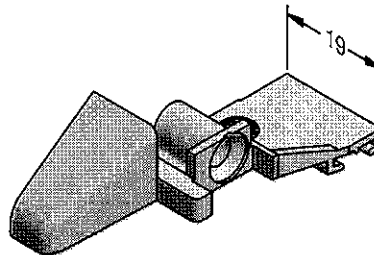

Endkappe Wetterschenkel 15 ED86 plus
ASA

1353011

1353012

50

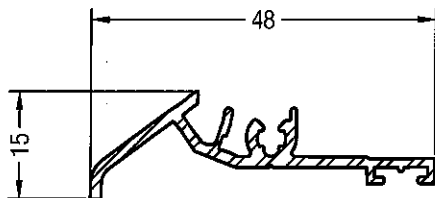

Wetterschenkel 15 ED86 plus

1353010

6



	1248095
	50

Zubehör außen öffnende Elemente

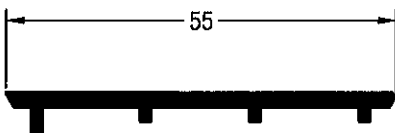

Falzeinlageprofil ED86 plus

1532740

72